



**COTTO D'ESTE**  
Nuove Superfici

**SECRET STONE**  
TIMELESS BEAUTY

**COTTO D'ESTE**<sup>®</sup> | LA  
Nuove Superfici | BELLEZZA  
IN  
CERAMICA



**SECRET STONE**  
TIMELESS BEAUTY



Un mistero mediorientale di eleganza e armonia, scritto nel linguaggio segreto della pietra e custodito dalle sabbie del deserto, riportato alla luce da Cotto d'Este.

Secret Stone è un prodotto straordinario, il risultato di una ricerca appassionante sulla pietra di Gerusalemme e della capacità di Cotto d'Este di raccoglierne la bellezza e superarne la qualità.

Le più belle e rare varietà cromatiche e le più significative stratificazioni riprodotte in altissima definizione, l'alta tecnologia produttiva e le ricercate finiture superficiali fanno di Secret Stone una collezione in gres porcellanato spessorato dal realismo senza precedenti.

Una pietra ideale per i professionisti che ricercano per i loro progetti architettonici soluzioni esclusive e di prestigio.

**COTTO D'ESTE**  
Nuove Superfici





# SECRET STONE TIMELESS BEAUTY

A Middle Eastern mystery of elegance and harmony, written in the secret of the stone and guarded by the desert sands, unearthed by Cotto d'Este.

Secret Stone is an amazing product, the result of fascinating research into Jerusalem stone and Cotto d'Este's capacity to capture its beauty and improve its quality.

The most beautiful and rarest varieties of colour and the most beautiful strata are reproduced in high definition. The high technology production process and refined surface finishes make the Secret Stone collection of thickened porcelain stoneware unprecedented in terms of realism.

A stone which is ideal for professionals seeking exclusive and prestige solutions for their architectural designs.



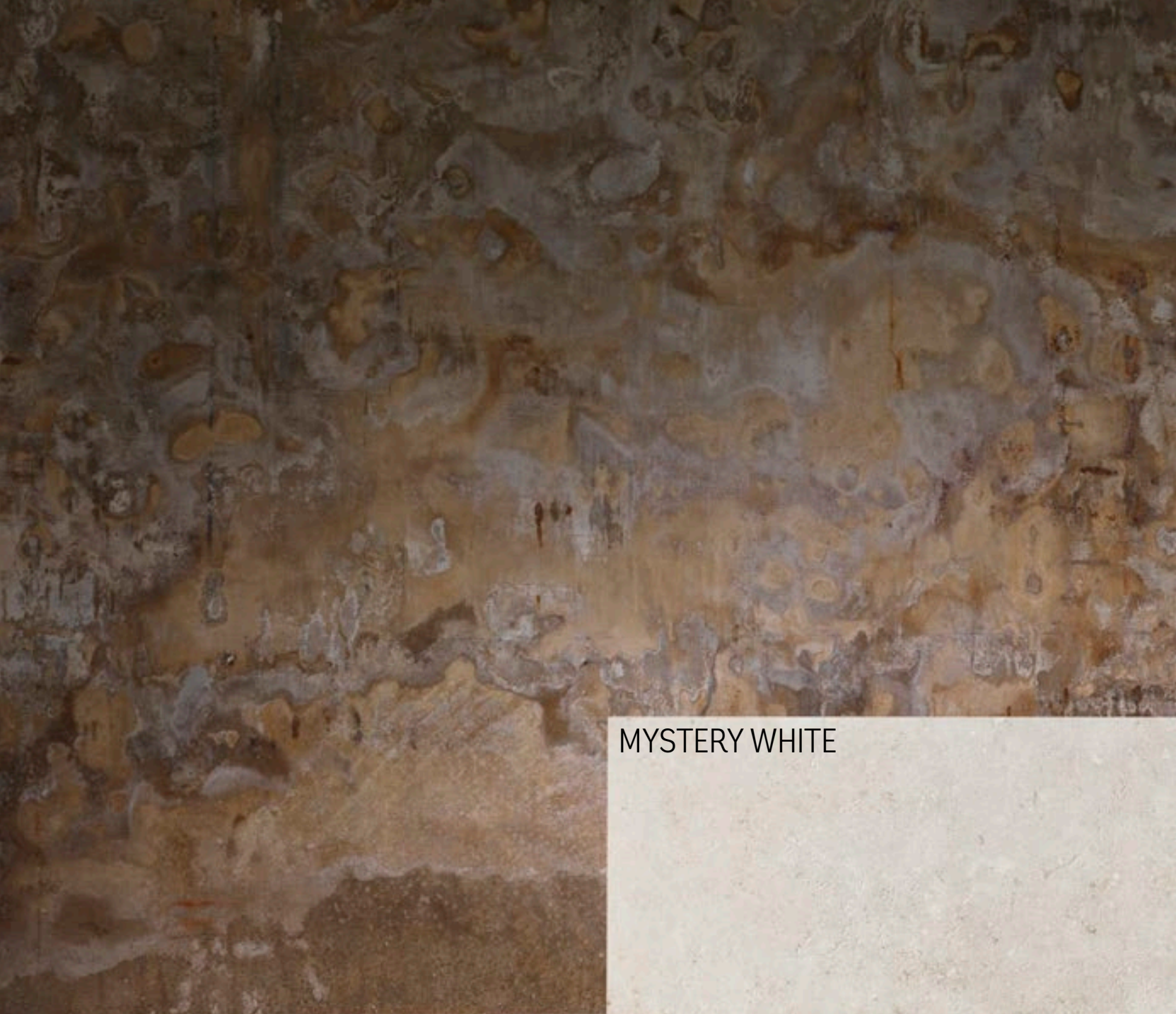

MYSTERY WHITE



cm 90x90

PRECIOUS BEIGE



cm 60x60

**14mm**  
EXTRA THICK  
PORCELAIN  
STONEWARE

SHADOW GREY



cm 60x120



RARE DARK



cm 30x60

COLOURS AND SIZES





GRIP

NATURAL

HONED









PRECIOUS BEIGE NATURAL RETT.  
cm 60x60 - 30x60





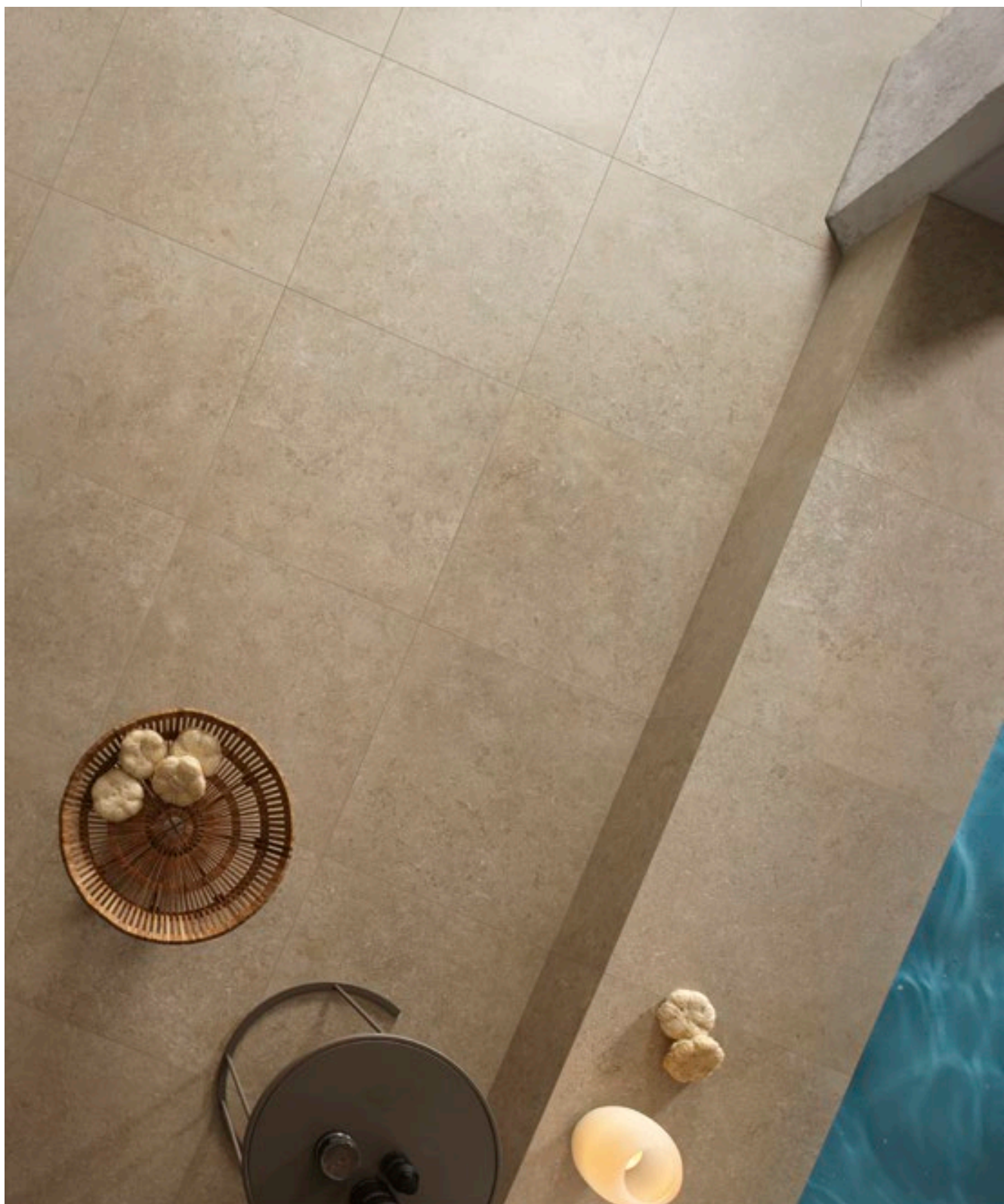

**PRECIOUS BEIGE NATURAL RETT.**  
cm 60x60 - 30x60







PRECIOUS BEIGE NATURAL RETT.  
cm 60x60









**PRECIOUS BEIGE HONED RETT.**  
cm 60X120  
Gradino Plus / Thin step tread Plus (cm 34x120)







Live  
with  
Love

MYSTERY WHITE HONED RETT.  
cm 90X90







MYSTERY WHITE HONED RETT.  
cm 90X90







MYSTERY WHITE GRIP RETT.  
cm 60X60





Algae, nerinee e conchiglie fossili, venature calcaree, sfumature minerali: ogni pezzo è come una bellissima pagina di storia geologica, fissata nella pietra dal paziente lavoro di tempo e natura.

Algae, nerine and fossil shells, limestone veins, mineral nuances: each piece is like a beautiful page of geologic history, set in stone by the patient work of time and nature.





RARE DARK NATURAL RETT.  
cm 90x90







RARE DARK HONED RETT.  
cm 60X120







La casa sem...

RARE DARK HONED RETT.  
cm 60X120





**SHADOW GREY NATURAL RETT.**  
cm 60X120



SHADOW GREY NATURAL RETT.  
cm 90X90









SHADOW GREY HONED RETT.  
cm 60x120







SHADOW GREY HONED RETT.  
cm 60X120





# GRES PORCELLANATO SPESSORATO EXTRA THICK PORCELAIN STONWARE

Conforme/In compliance with: ISO 13006-G, EN 14411-G, ANSI A137.1

Massa/Body: **Bla UGL - IMPASTO COLORATO / FULL COLOR**

Decorazione/Decoration: **INKJET - EFFETTO 3D / 3D EFFECT**

**PRESSATO 3 VOLTE.** Per una perfetta compattazione della materia prima, l'impasto viene pressato con 3 battute in sequenza e una forza massima di 6.200 tonnellate.

**COTTO PER OLTRE 90 MINUTI FINO A 1230°C.** Solo una cottura lunga oltre il doppio della media del gres tradizionale di spessore 10 mm e temperature così elevate consentono una perfetta greificazione della massa. Questo si traduce in resistenza e inalterabilità delle superfici nel tempo.

**PRESSED 3 TIMES.** To guarantee perfect compacting of the raw material, the body is pressed 3 times, with a sequence of 3 press strokes, and at a maximum force of 6200 tons.

**FIRED FOR OVER 90 MINUTES UP TO 1230°C.** Only a firing cycle that is twice as long as the average cycle for conventional 10 mm thick porcelain stoneware and high temperatures can allow for perfect vitrification of the body. This results in resistance and surfaces that resist time and wear.

GUARDA IL TEST  
DEL CARICO DI  
ROTTURA

WATCH THE  
BREAKING LOAD  
TEST



### ALTAMENTE SPESSORATO

14 mm

### HIGH THICKNESS

14 mm



### 3 VOLTE PIU' RESISTENTE AL CARICO DI ROTTURA

RISPETTO ALLA MEDIA DEI PRODOTTI GENERALI IN SPESSORE 10 mm

### ON AVERAGE 3 TIMES MORE RESISTANT TO BREAKING

WITH RESPECT TO GENERAL PRODUCTS WITH A THICKNESS OF 10 mm



### GARANTITO FINO A 20 ANNI

LA BELLEZZA E LA STRAORDINARIA QUALITÀ DEI NOSTRI PAVIMENTI SONO VALORI CHE DURANO NEL TEMPO

### GUARANTEED UNTIL 20 YEARS

THE BEAUTY AND EXTRAORDINARY QUALITY OF OUR FLOORS ARE VALUES THAT RESIST TIME

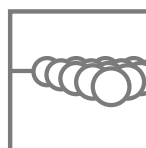

### STRAORDINARIA PLANARITÀ

ANCHE NEI GRANDI FORMATI

### EXTRAORDINARY FLATNESS

EVEN WITH LARGE SIZES



### FACILE

DA PULIRE

### EASY

TO CLEAN



### PIÙ RESISTENTE AGLI URTI

LA SUPERFICIE DELLE MATTONELLE DI SPESSORE 14 MM DIMOSTRA UNA ECCEZIONALE RESISTENZA AGLI URTI, COME CERTIFICANO I TEST A NORMA CSTB

### MORE RESISTANT TO IMPACT

THE SURFACE OF 14 MM THICK TILES HAS AN EXCELLENT RESISTANCE TO IMPACT, AS CERTIFIED BY TESTS PERFORMED IN COMPLIANCE WITH CSTB STANDARDS



### CARRABILE

RESISTE AL TRANSITO DI AUTOMEZZI PESANTI NEI FORMATI FINO A 60X60 (SE POSATI CORRETTAMENTE SU SOTTOFONDI IDONEI ALLA DESTINAZIONE D'USO)

### TRANSITABLE

WITH SIZES UP TO 60X60 CM, RESISTS TRAFFIC OF HEAVY MOTOR VEHICLES (IF CORRECTLY INSTALLED ON SUBSTRATES THAT ARE SUITABLE FOR THE INTENDED USE)



### ANTIBATTERICO

GRAZIE ALLA TECNOLOGIA INTEGRATA SEMPRE ATTIVA

### ANTIMICROBIAL

THANKS TO INTEGRATED TECHNOLOGY WHICH IS ALWAYS ACTIVE



### ECOSOSTENIBILE

MINORI EMISSIONI DI CO<sub>2</sub>, MINOR CONSUMO DI MATERIE PRIME E MINOR PRODUZIONE DI SCARTI E TRASPORTI. FONTI ENERGETICHE RINNOVABILI

### ECO-FRIENDLY

LESS ENERGY CONSUMPTION AND LESS CO<sub>2</sub> EMISSIONS, LESS CONSUMPTION OF RAW MATERIALS, LESS PRODUCTION OF WASTE AND LESS POLLUTION DUE TO TRANSPORT. RENEWABLE ENERGY SOURCES

## CARATTERISTICHE TECNICHE TECHNICAL FEATURES

### RESISTENZA ALLO SCIVOLAMENTO SLIPPERING RESISTANCE

DIN 51130	R11 GRIP - R10 NATURAL
DIN 51097	C(A+B+C) GRIP - B(A+B) NATURAL
BCR-TORTUS	$\mu > 0,40$ GRIP, NATURAL, HONED
ANSI A137.1-BOT 3000	DCOF $\geq 0,42$ GRIP, NATURAL, HONED
UNE ENV 12633 Pendulum	CLASE 3 GRIP - CLASE 1 HONED
BS 7976 British pendulum test	PTV 36+Wet - Slider 96 GRIP

### CARICO DI ROTTURA (S) - Valore medio BREAKING STRENGTH (S) - Average value

ISO 10545-4	$\geq 620$ kg ( $\geq 6080$ N)
ASTM C 648	$\geq 1364$ lbs

### RESISTENZA ALLA FLESSIONE - Valore medio BENDING STRENGTH - Average value

ISO 10545-4	$\geq 510$ kg/cm <sup>2</sup> ( $\geq 50$ N/mm <sup>2</sup> )
-------------	---

### RESISTENZA ALL'ABRASIONE PROFONDA - Valore medio DEEP ABRASION RESISTANCE - Average value

ISO 10545-6	$\leq 134$ mm <sup>3</sup>
-------------	----------------------------

### RESISTENZA ALLE MACCHIE STAIN RESISTANCE

ISO 10545-14	CLASSE 5
--------------	----------

### RESISTENZA ALL'ATTACCO CHIMICO RESISTANCE TO CHEMICAL ETCHING

ISO 10545-13	ULA-UHA	<i>No acido fluoridrico e derivati Not resistant to hydrofluoric acid and derivatives</i>
--------------	---------	---

### ASSORBIMENTO D'ACQUA WATER ABSORPTION

ISO 10545-3	$\leq 0,05\%$
-------------	---------------

### RESISTENZA AL GELO FROST RESISTANCE

ISO 10545-12	INGELIVO - FROST PROOF
--------------	------------------------

### STONALIZZAZIONE DESHADING

ANSI A137.1	V2
-------------	----

## PULIBILITÀ PULIBILITY

### VISIBILITÀ DELLE IMPRONTE - Metodo Cotto d'Este

Questa classificazione specifica il grado di visibilità delle impronte rilasciate sul pavimento dopo il passaggio con scarpe sporche di polvere.

**A** - Impronta non visibile

**B** - Impronta poco visibile

**C** - Impronta molto visibile. Ideale per rivestimenti e consigliato per pavimenti solo in ambienti residenziali.

### TREAD MARK VISIBILITY - Cotto d'Este method

This classification specifies the visibility degree of the tread marks left on the floor after walking with shoes dirty of dust.

**A** - Tread mark not visible

**B** - Tread mark not very visible.

**C** - Tread mark very visible. Ideal for wall installation and recommended for floor installation in residential areas only.

### A HONED - B GRIP, NATURAL

### FACILITÀ DI PULIZIA - Metodo Cotto d'Este

Il metodo consiste nel classificare il grado di facilità nella rimozione dello sporco generico mediante pulizia manuale con detergente debole.

**Grado 1** - Molto facile, nessuna resistenza dello sporco, rimozione immediata.

**Grado 2** - Facile, leggera resistenza dello sporco, rimozione veloce.

**Grado 3** - Meno facile, maggiore resistenza dello sporco, rimozione lenta. Si consiglia detergente forte. Ideale per rivestimenti e consigliato per pavimenti solo in ambienti residenziali.

### CLEANING EASINESS - Cotto d'Este method

The method consists in classifying the easiness grade in removing general dirt by manual cleaning with mild detergent.

**Grade 1** - Very easy, no resistance of the dirt, immediate removal.

**Grade 2** - Easy, light resistance of the dirt, fast removal.

**Grade 3** - Less easy, higher resistance of the dirt, slow removal. A strong detergent is recommended. Ideal for wall installation and recommended for floor installation in residential areas only.

## CERTIFICAZIONI CERTIFICATIONS



EN 14411

Le DOP sono disponibili sul sito internet [www.cottodeste.it](http://www.cottodeste.it)  
DOP are available on the website [www.cottodeste.it](http://www.cottodeste.it)



Sistema di gestione della qualità siti produttivi  
Quality management system of production sites



Sistema di gestione ambientale siti produttivi  
Environmental management system of production sites



EMAS  
GESTIONE AMBIENTALE  
VERIFICATA  
Reg. n. 14002/99  
STABILIMENTO DI FINALE EMILIA (MO)



EMAS  
GESTIONE AMBIENTALE  
VERIFICATA  
Reg. n. 14002/99  
STABILIMENTO DI TOANO (RE)



Cotto d'Este, tramite la holding Panariagroup Industrie Ceramiche S.p.A., è membro dello U.S. Green Building Council e del Green Building Council Italia.

Cotto d'Este, through Panariagroup Industrie Ceramiche S.p.A. holding, is a member of the U.S. Green Building Council and of the Italian Green Building Council.

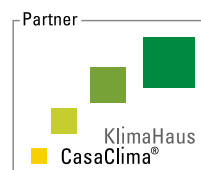

GREEN  
MISSION

**SANO SICURO ECOSOSTENIBILE.** Cotto d'Este ha scelto di schierarsi in difesa del pianeta. Lo ha fatto e continua a farlo ogni giorno con azioni concrete, attraverso investimenti in tecnologie più evolute e scelte produttive che rispondono a logiche di ecosostenibilità.

Perché in fondo, pur essendo il risultato di un processo industriale complesso e tecnologicamente avanzato, la ceramica resta un prodotto naturale. Una ricetta semplice, fatta di pochi elementi essenziali come terra, acqua e fuoco, consente di ottenere un prodotto resistente e versatile, pratico e igienico, che vanta un elevato valore in termini di bellezza e design. Tanto più se la filiera produttiva dialoga con l'ambiente in maniera responsabile: riducendo il fabbisogno di materie prime, riciclando acque e scarti di lavorazione, impiegando energie rinnovabili e gestendole con impianti ad alta efficienza. Riducendo in sostanza l'impronta ecologica che la produzione industriale imprime sulla superficie del pianeta.

**HEALTHY SAFE ECOFRIENDLY.** Cotto d'Este has chosen to take a stand in defence of the planet. The company has an on-going commitment to minimise its environmental impact through concrete actions carried out every day. These include investing in the most advanced technologies and making production decisions based on logics of sustainability. Despite being the result of a complex industrial and technologically advanced process, ceramics are a natural product. Following a simple recipe, composed of a few essential elements such as earth, fire and water, it is possible to obtain a strong, versatile, practical and hygienic product, which has a high value in terms of beauty and design. This is particularly the case if the production chain interacts with the environment in a responsible way by reducing the need for raw materials, recycling water and waste products, using renewable energy and managing the process with high-efficiency systems, thus substantially reducing the carbon footprint that the industrial production leaves on the surface of the planet.

# SECRET STONE

TIMELESS BEAUTY

## COLORI / COLOURS



**MYSTERY WHITE**



**PRECIOUS BEIGE**

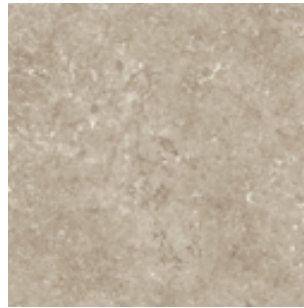

**SHADOW GREY**

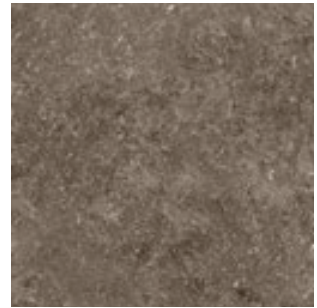

**RARE DARK**

## SPESSORE / THICKNESS

**14mm**

EXTRA THICK  
PORCELAIN  
STONEWARE

## SUPERFICI E FINITURE / SURFACES AND FINISHING

**NATURAL** RETTIFICATA E ROMPIFILO / RECTIFIED AND CHAMFER

**HONED** LAPPATA, RETTIFICATA E ROMPIFILO / HONED, RECTIFIED AND CHAMFER

**GRIP** RETTIFICATA E ROMPIFILO / RECTIFIED AND CHAMFER

## FORMATI / SIZES

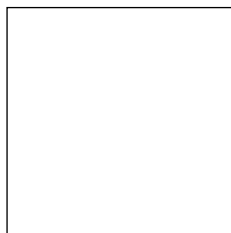

**90X90 cm**  
36"x36"  
NATURAL  
HONED



**60X120 cm**  
24"x48"  
NATURAL  
HONED

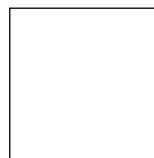

**60X60 cm**  
24"x24"  
NATURAL  
HONED  
GRIP



**30X60 cm**  
12"x24"  
NATURAL  
HONED  
GRIP

## PEZZI SPECIALI / SPECIAL PIECES

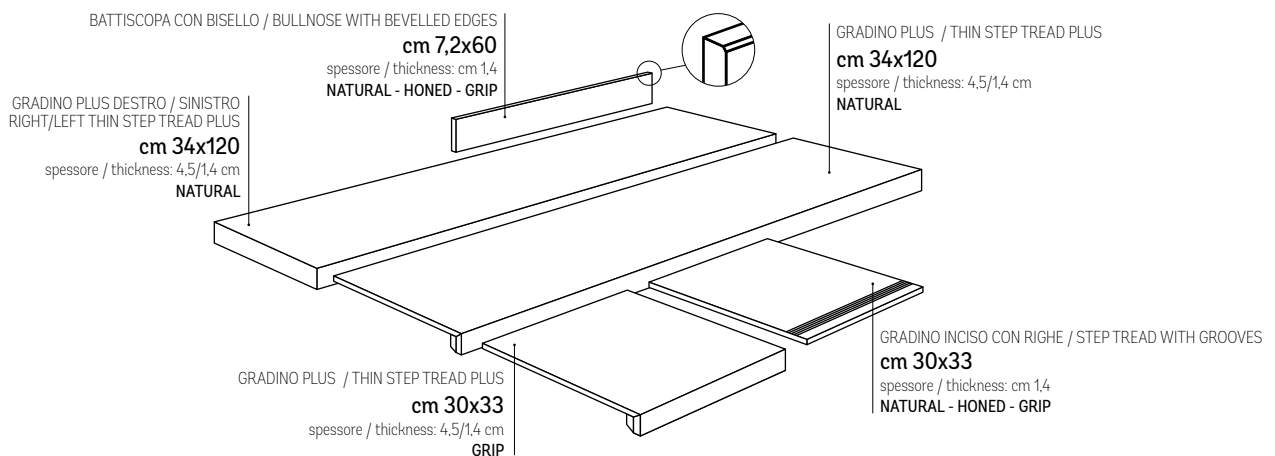

## GARANZIA / WARRANTY



**20 ANNI** RESIDENZIALE E PUBBLICO  
**20 YEARS** RESIDENTIAL AND PUBLIC

## PROTEZIONE ANTIBATTERICA ANTIMICROBIAL PROTECTION



NATURAL - HONED

**COTTO D'ESTE**<sup>®</sup> | LA  
Nuove Superfici | BELLEZZA  
IN  
CERAMICA

# COTTO D'ESTE®

Nuove Superfici

LA  
BELLEZZA  
IN  
CERAMICA

Via Emilia Romagna, 31 - 41049 Sassuolo (MO) Italy  
+39 0536 814 911 - fax +39 0536 814 921  
cottodeste.it - info@cottodeste.it  
PANARIAGROUP INDUSTRIE CERAMICHE S.p.A.

FOLLOW US ON:

